

Find the Perimeter of these Irregular Shapes.

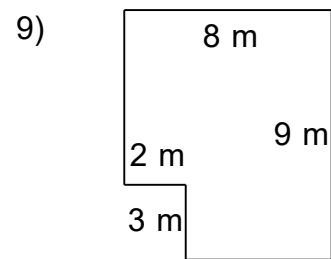

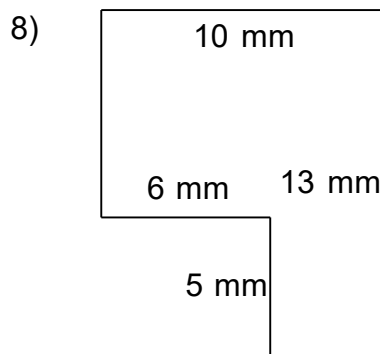

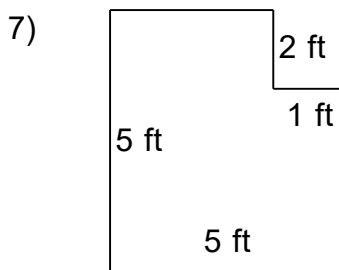

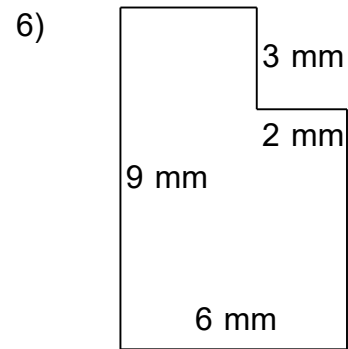
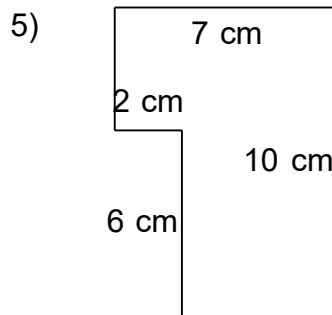
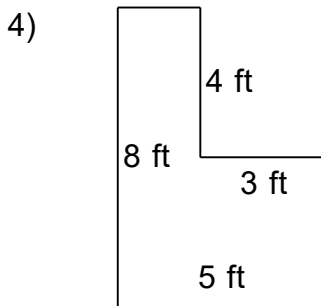
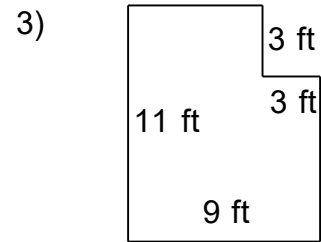
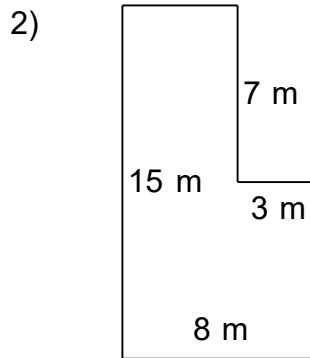
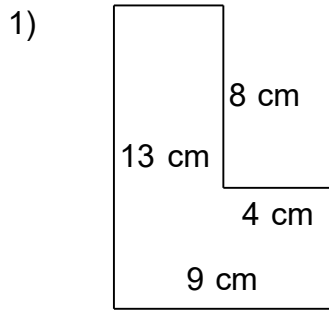
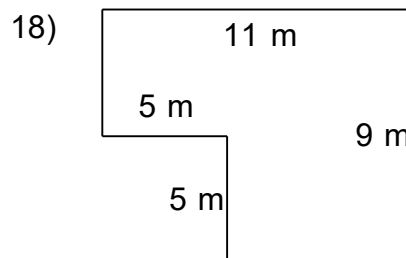
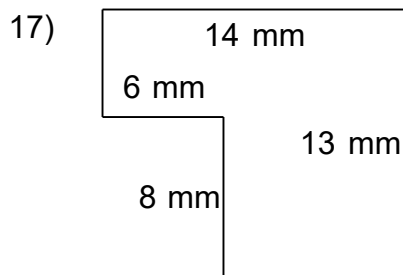
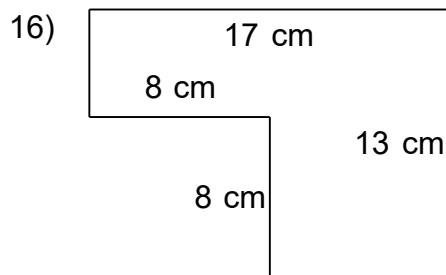
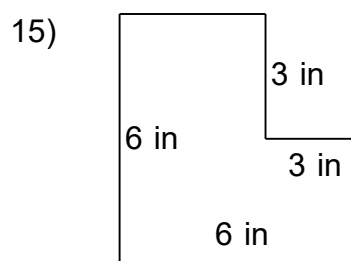
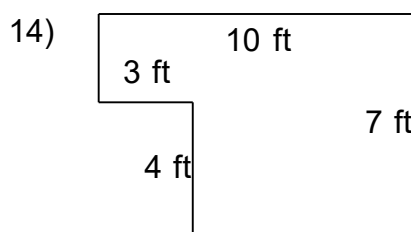
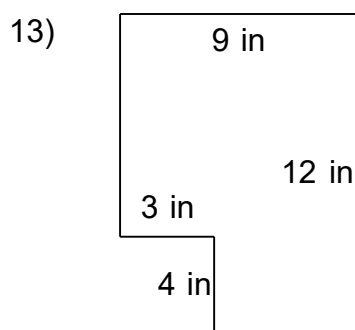
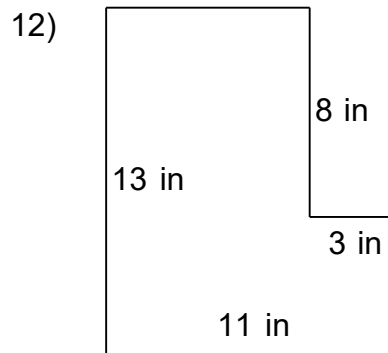
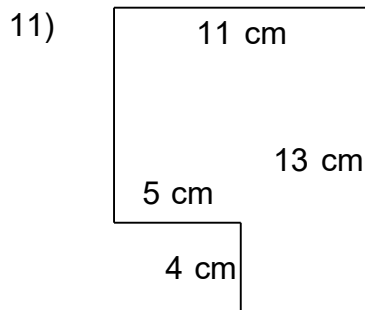
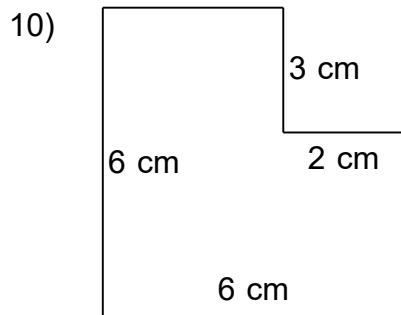
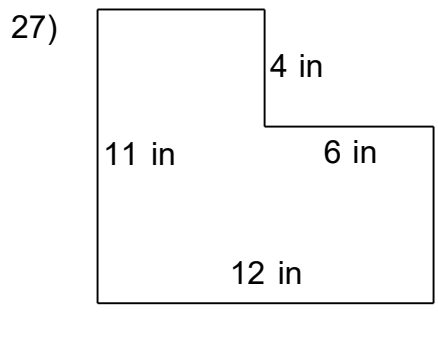
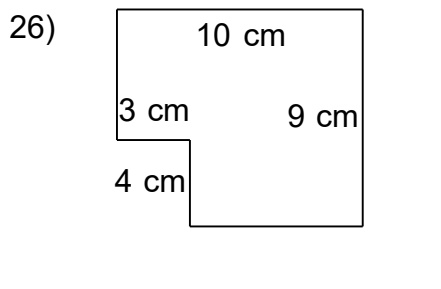
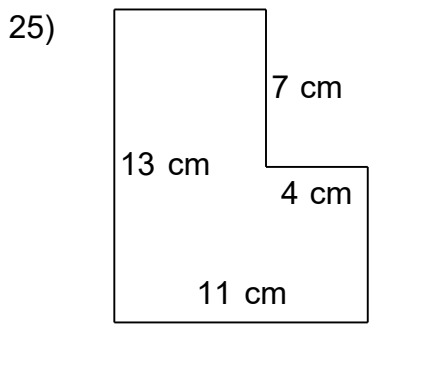
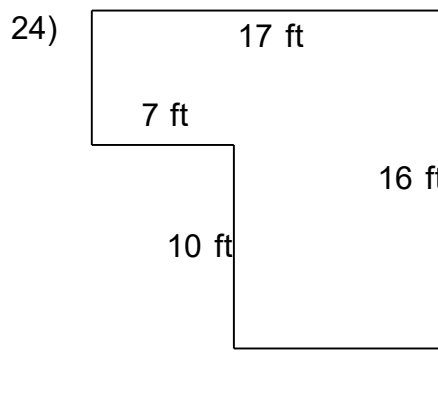
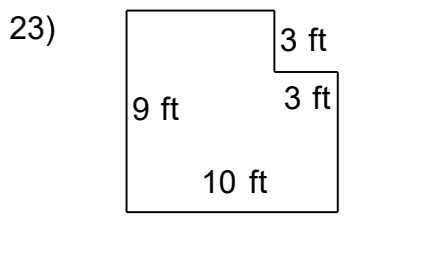
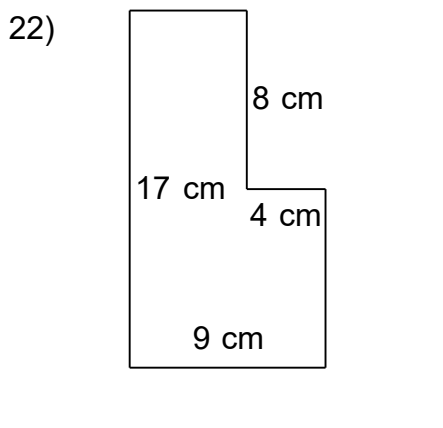
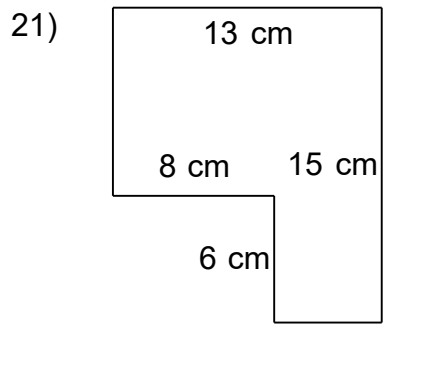
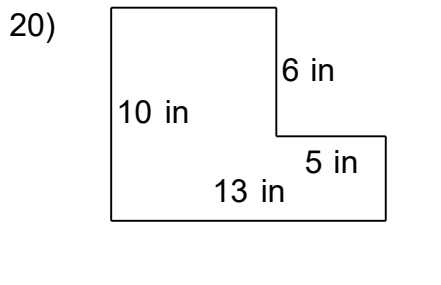
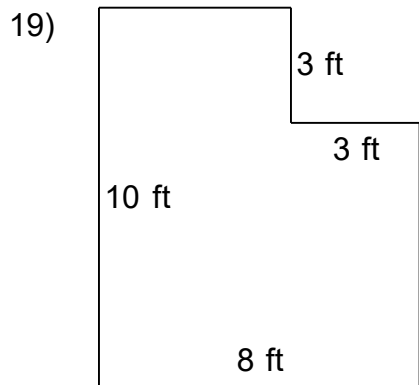
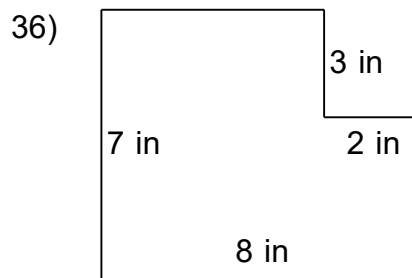
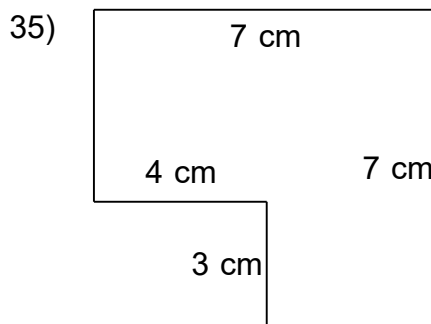
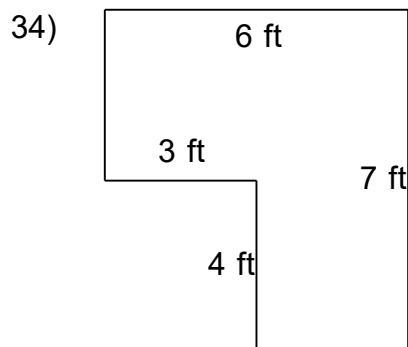
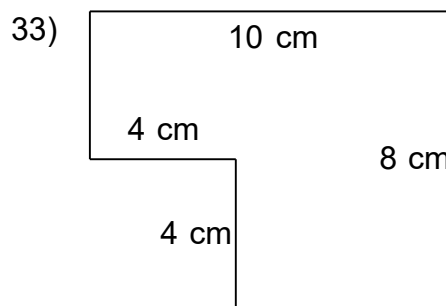
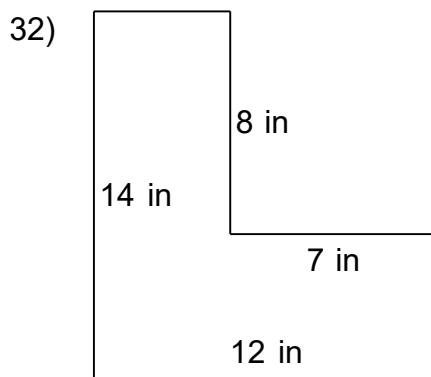
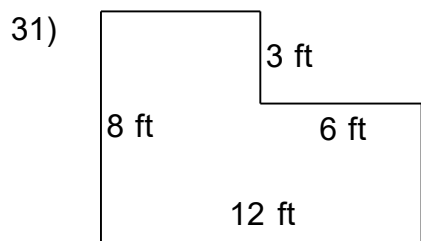
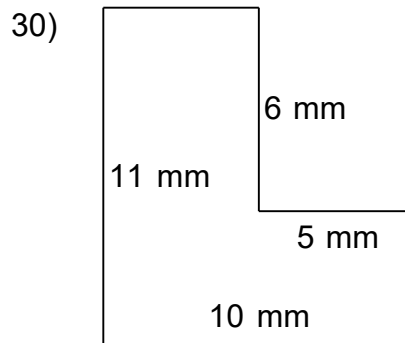
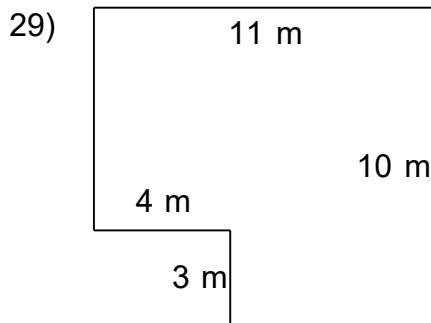
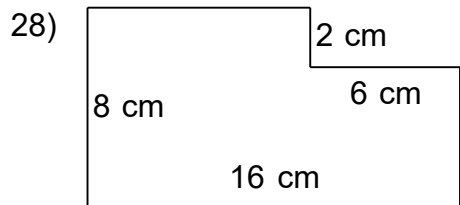

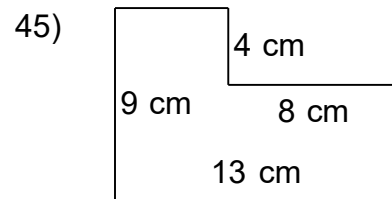
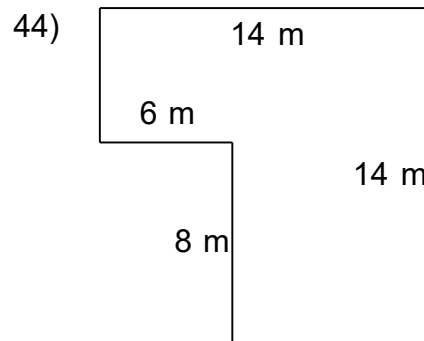
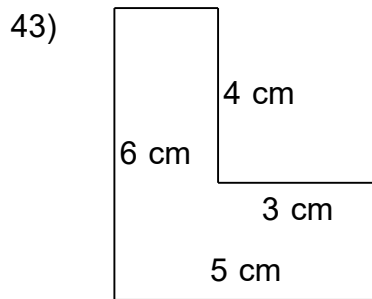
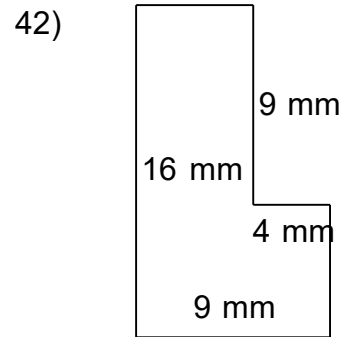
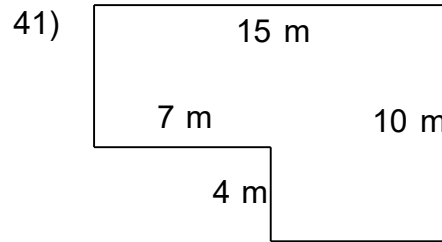
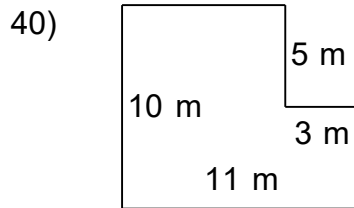
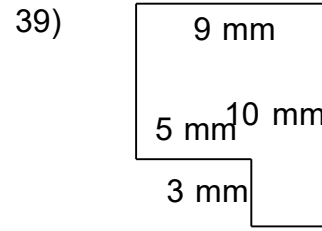
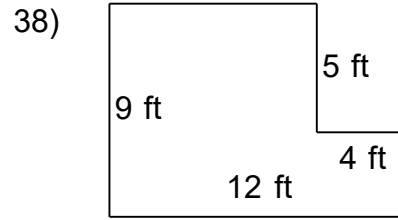
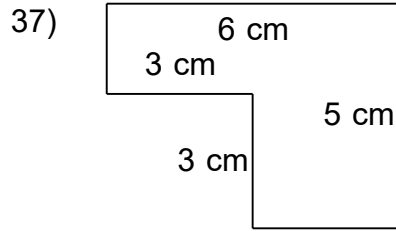

46)

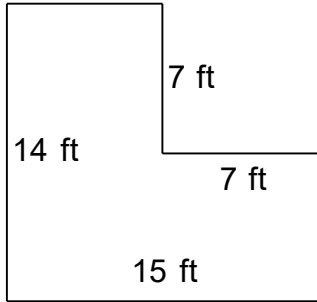

47)

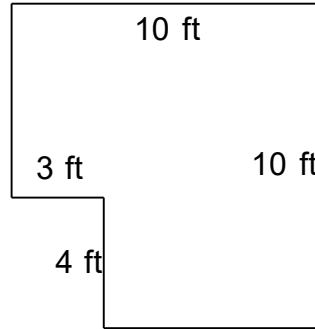

48)

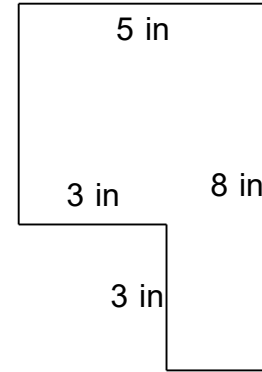

49)

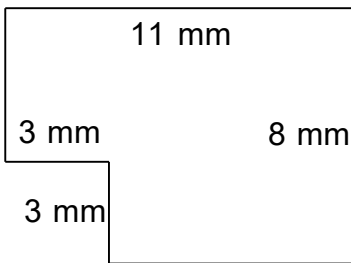

50)

