

Find the Area of these Parallelograms.

1)

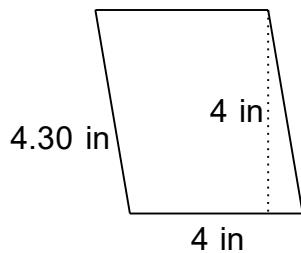

2)

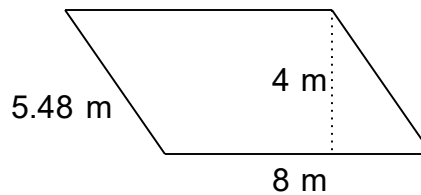

3)

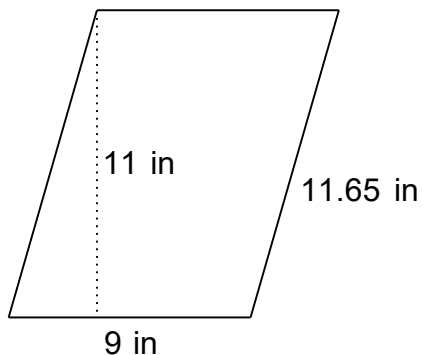

4)

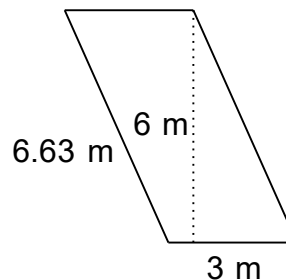

5)

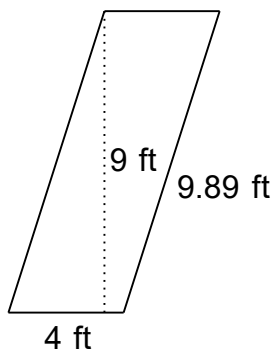

6)

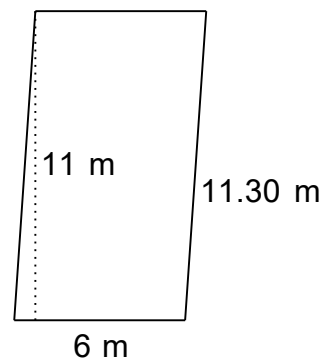

7)

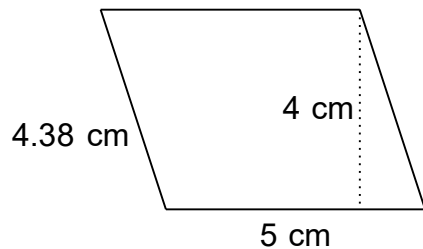

8)

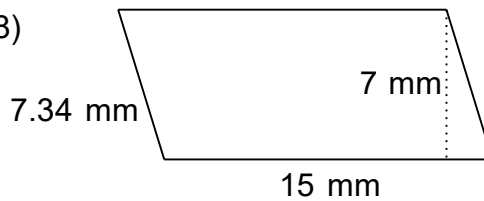

9)

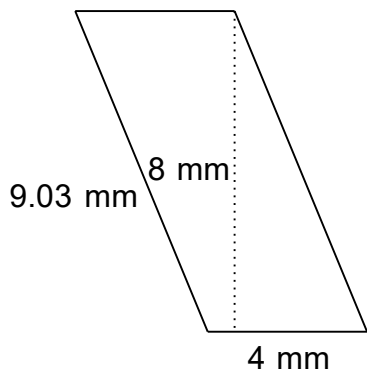

10)

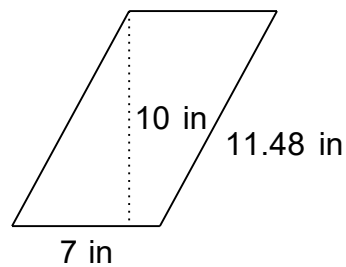

11)

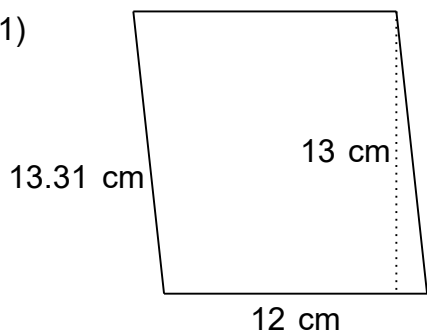

12)

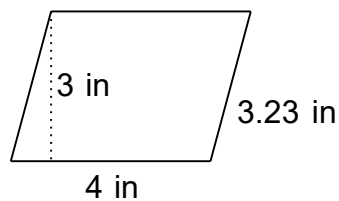

13)

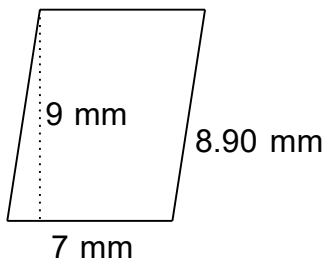

14)

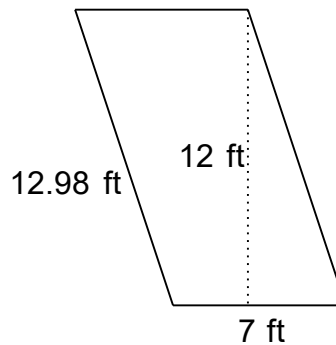

15)

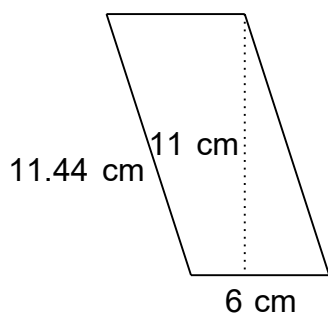

16)

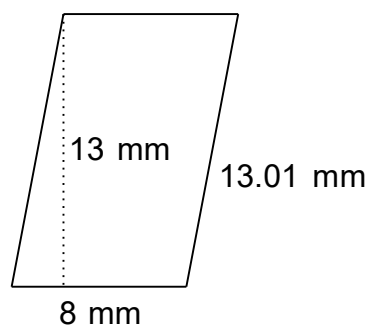

17)

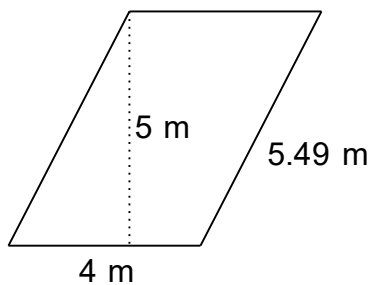

18)

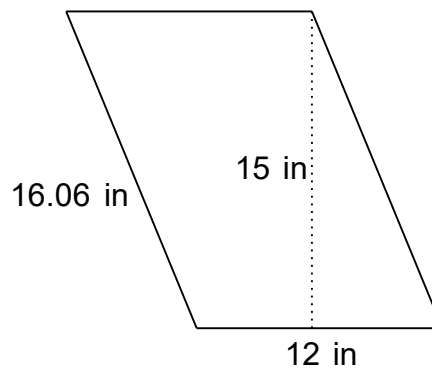

19)

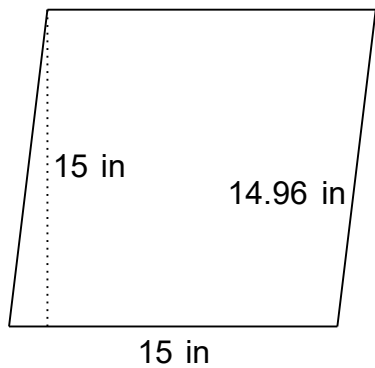

20)

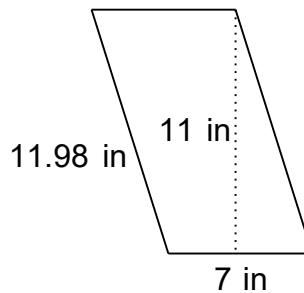

21)

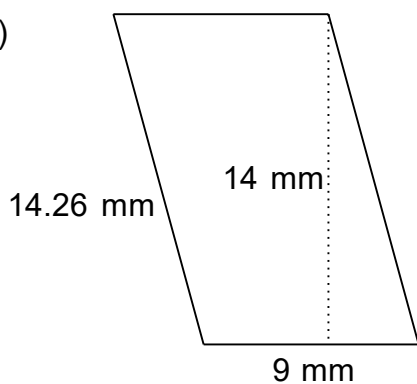

22)

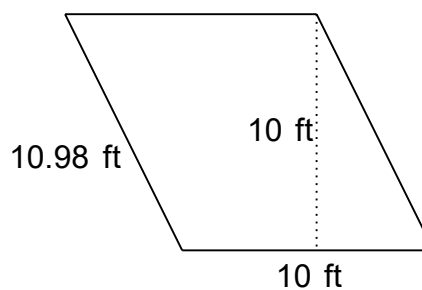

23)

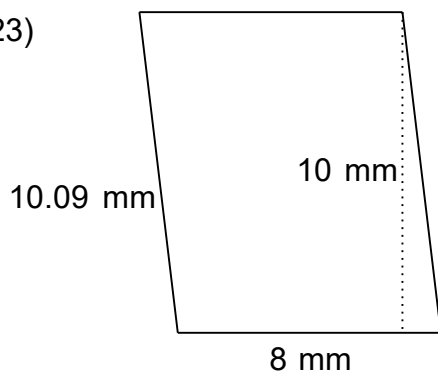

24)

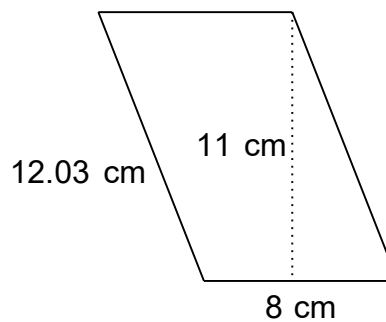

25)

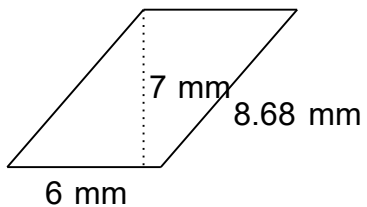

26)

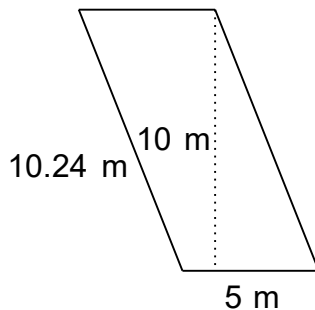

27)

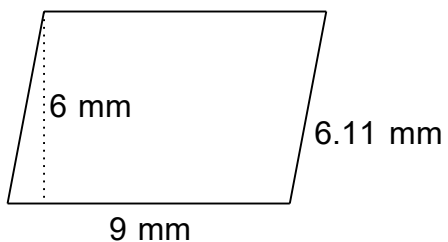

28)

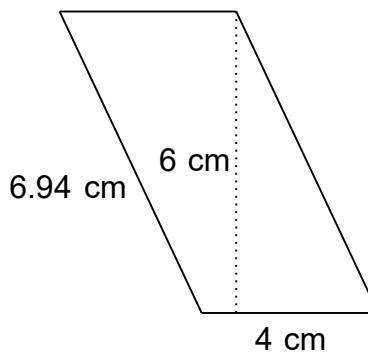

29)

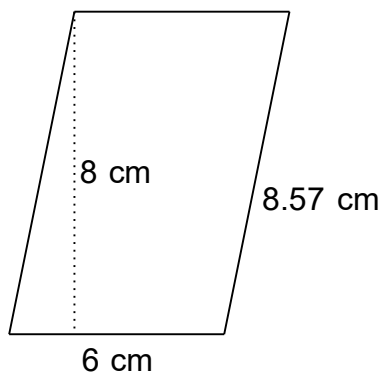

30)

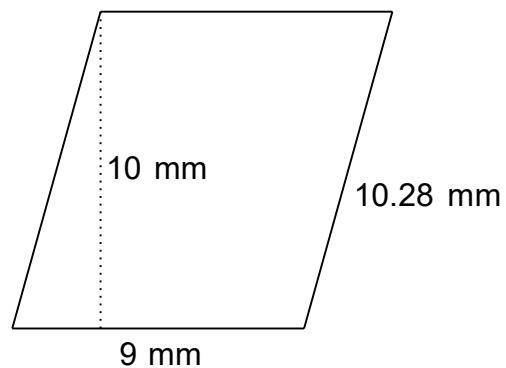

31)

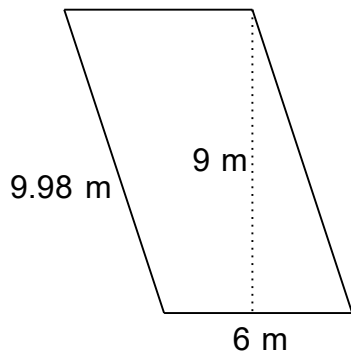

32)

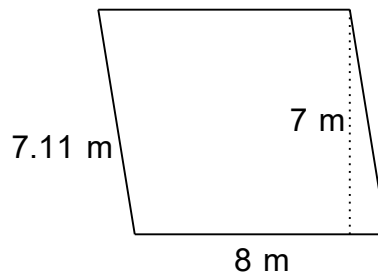

33)

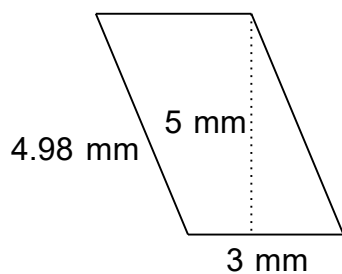

34)

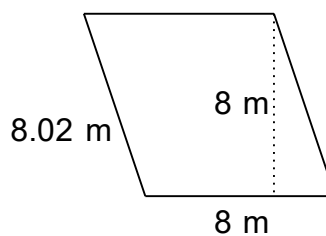

35)

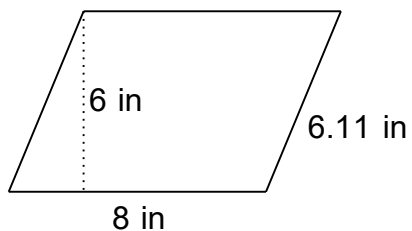

36)

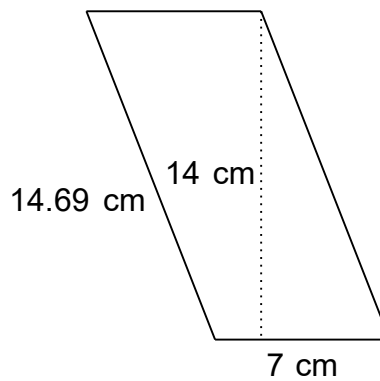

37)

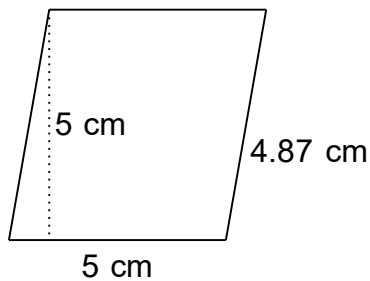

38)

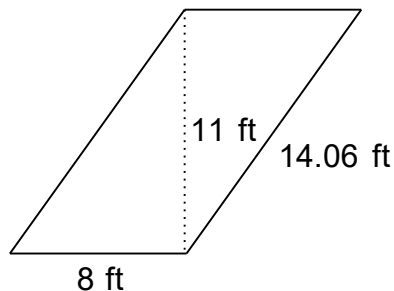

39)

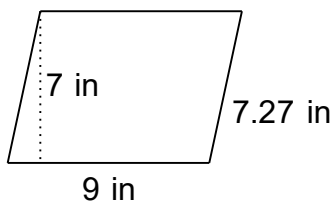

40)

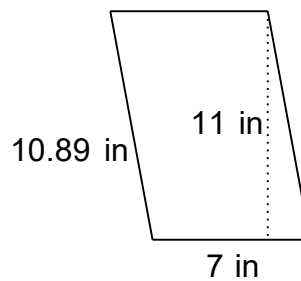

41)

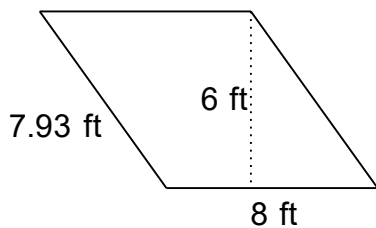

42)

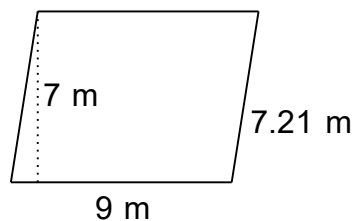

43)

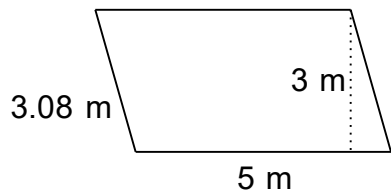

44)

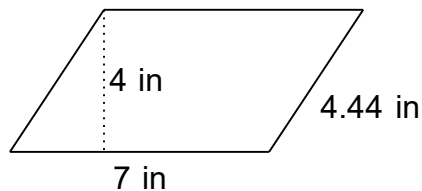

45)

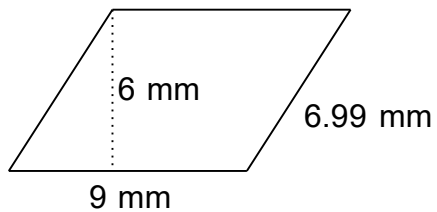

46)

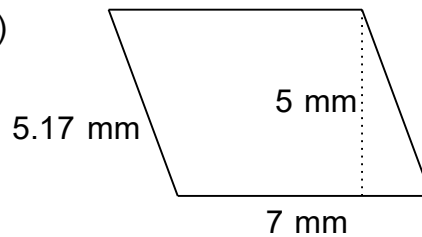

47)

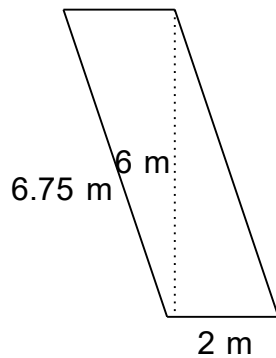

48)

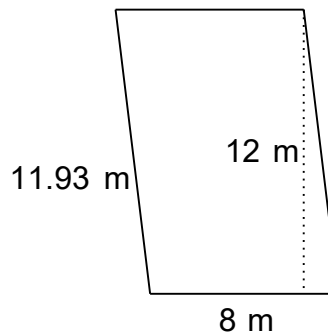

49)

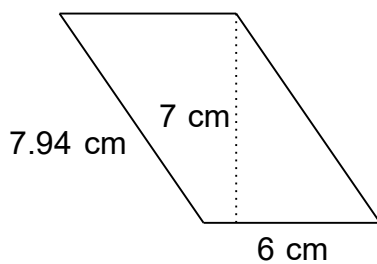

50)

