

Find the Area of the following Right Angle Triangles.

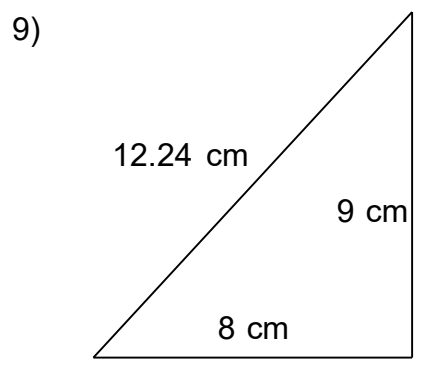

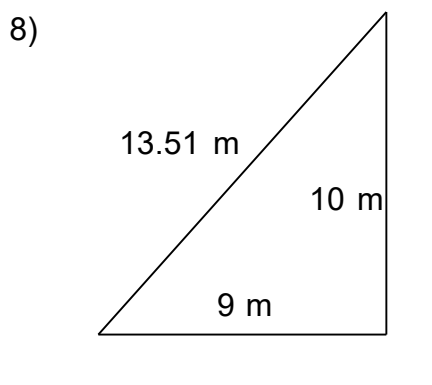

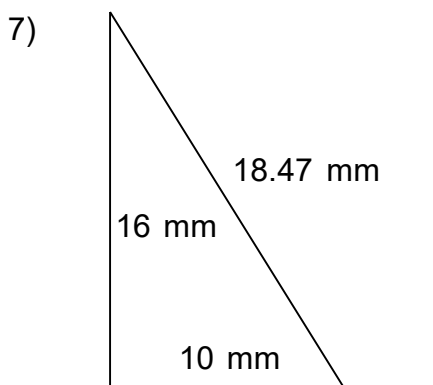
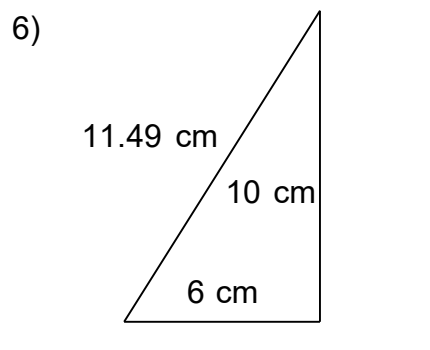
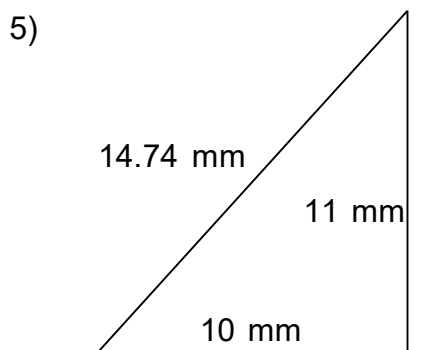
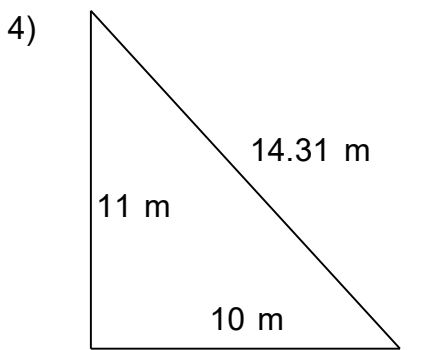
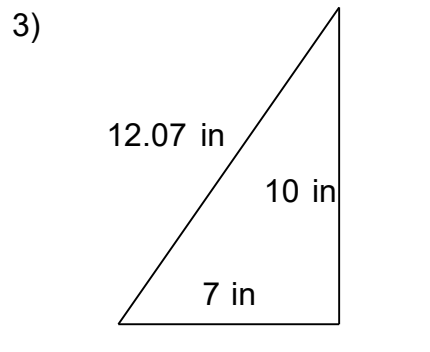
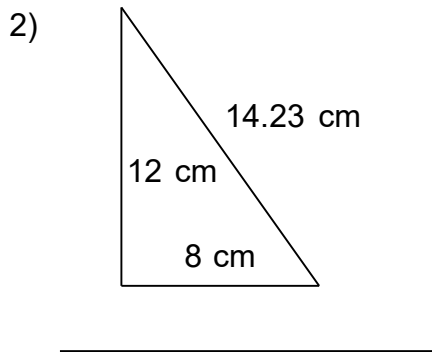
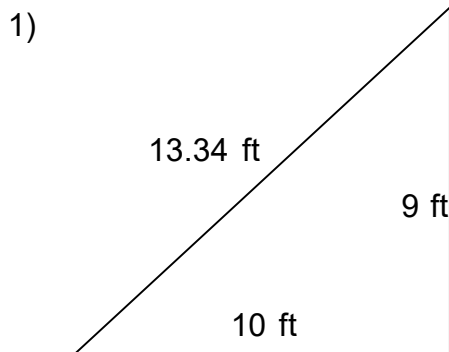
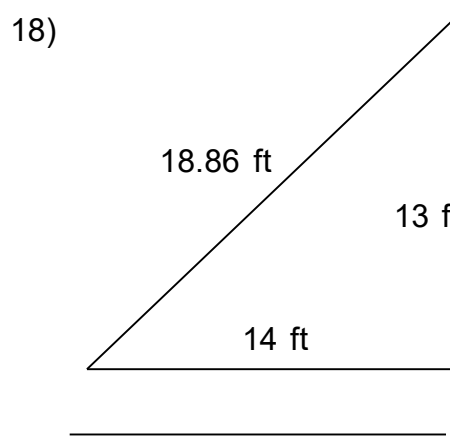
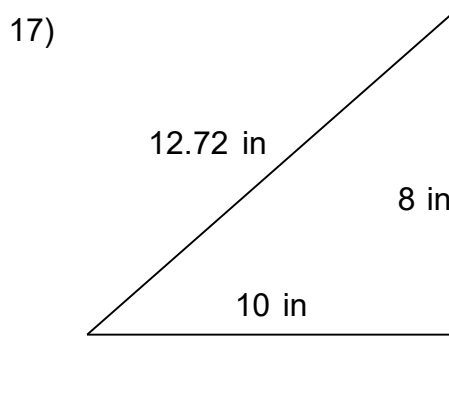
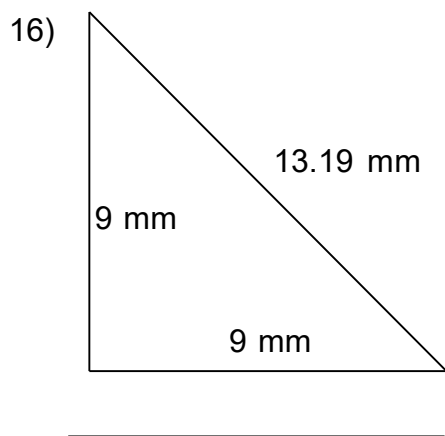
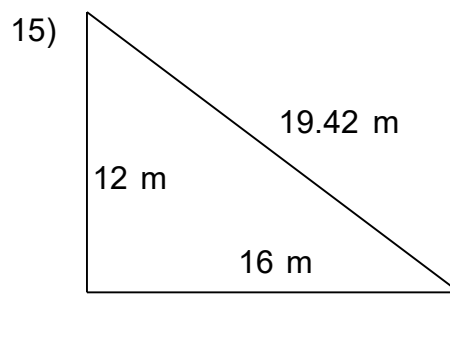
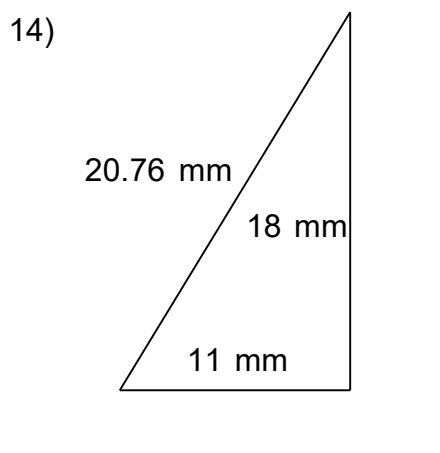
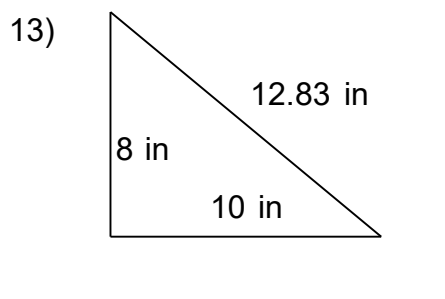
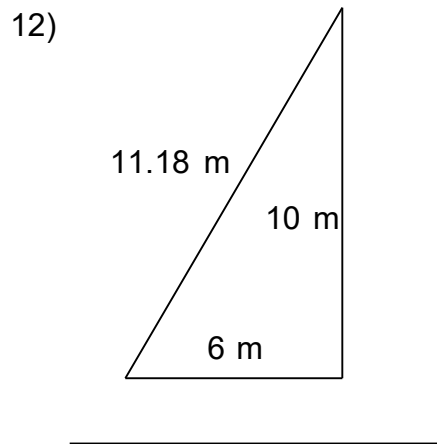
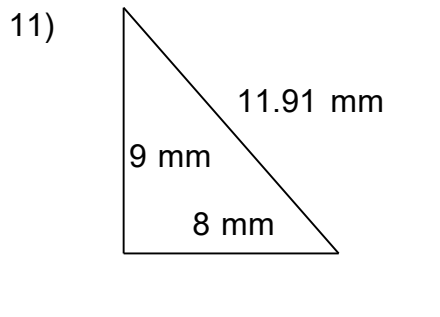
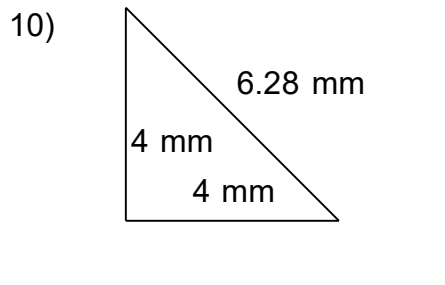
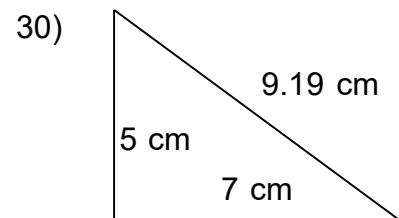
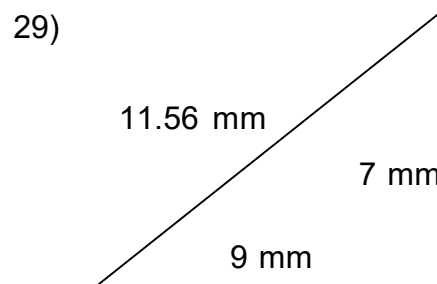
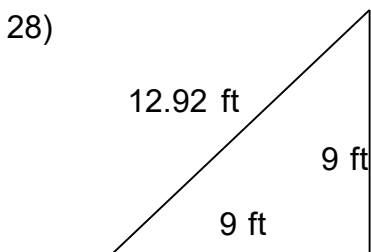
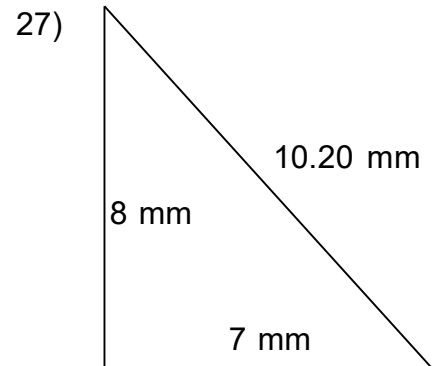
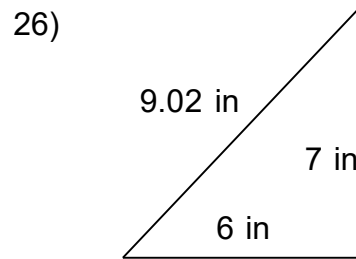
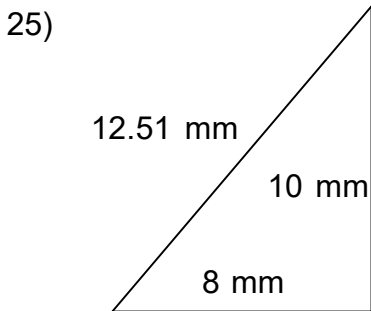
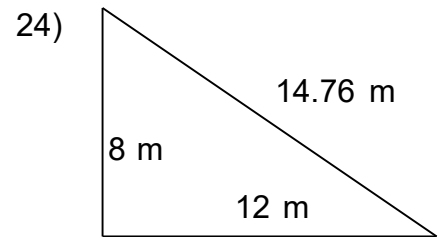
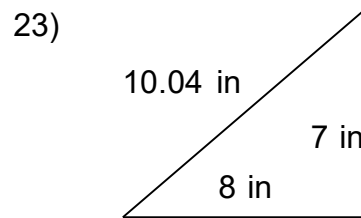
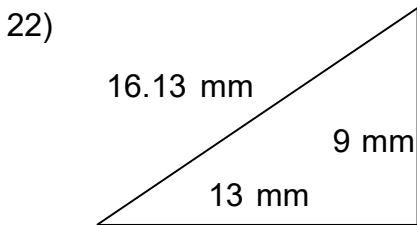
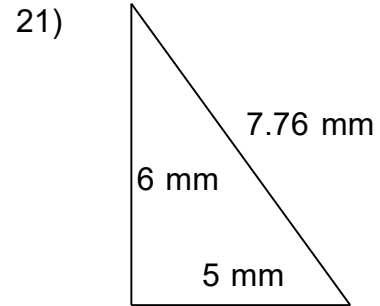
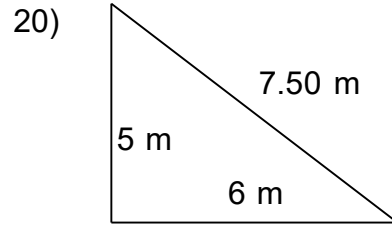
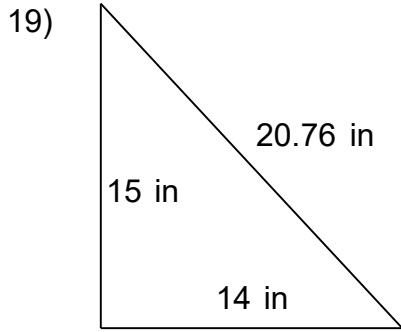

31)

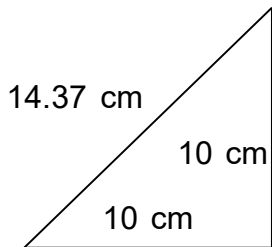

32)

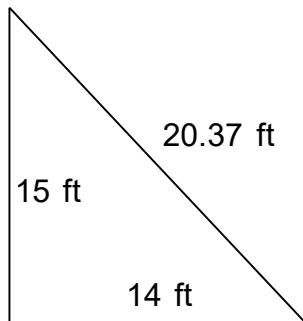

33)

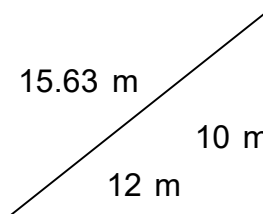

34)

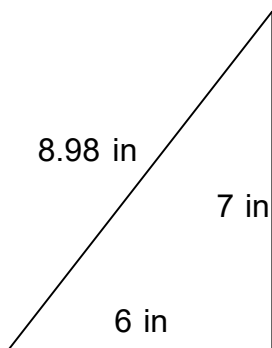

35)

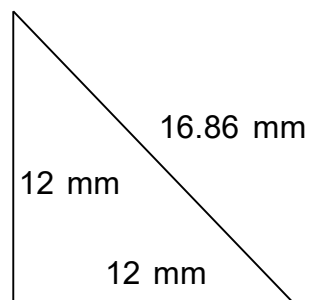

36)

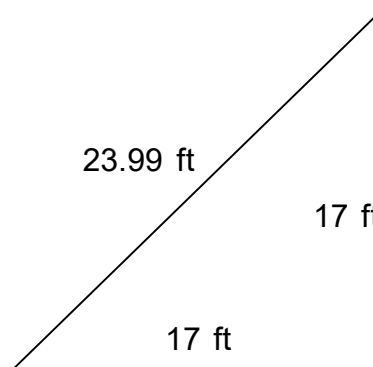

37)

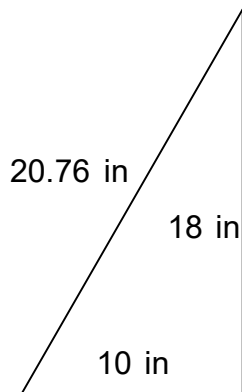

38)

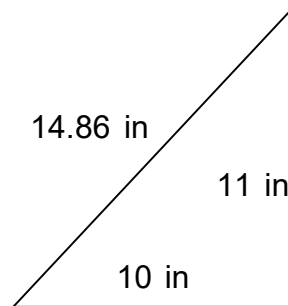

39)

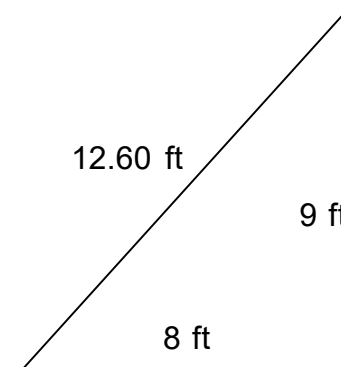

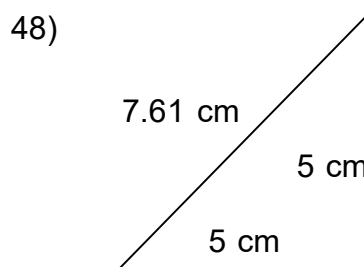
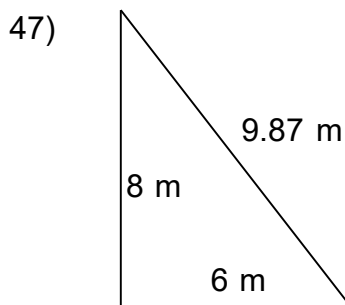
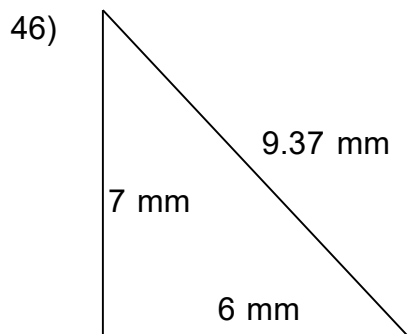
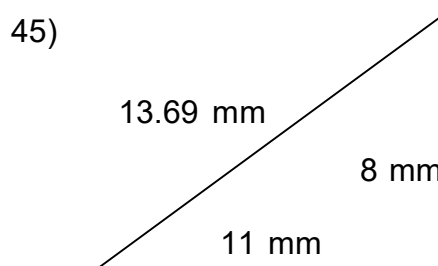
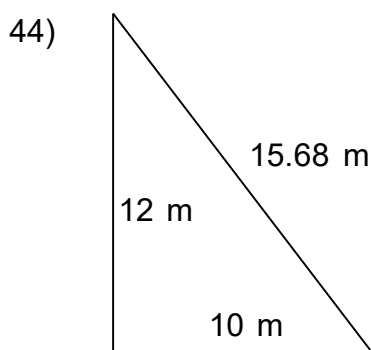
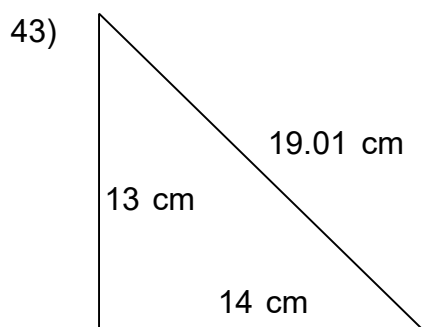
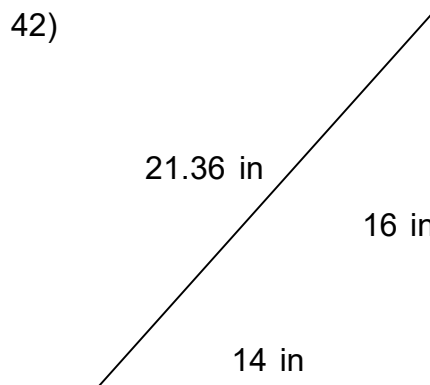
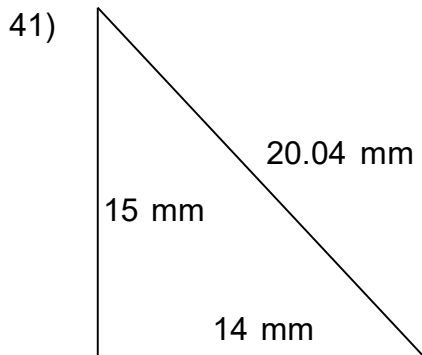
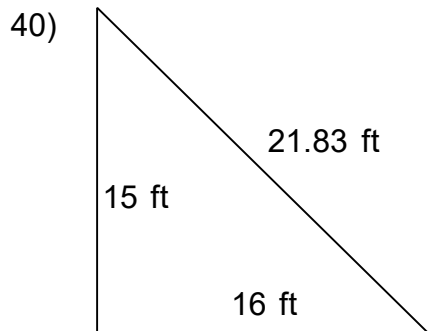

49)

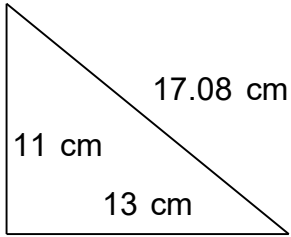

---

50)

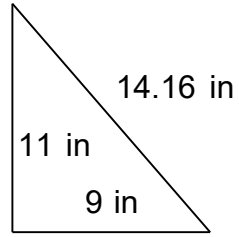

---